



**MORGAN
RUSHWORTH**
SHAPING THE INDUSTRY SINCE 1872

HBM - HORIZONTAL BENDING MACHINES

HORIZONTAL BENDING MACHINES

The Morgan Rushworth HBM Horizontal Bending Press range of machines are available with capacities from 10 ton up to 100 ton. These machines have proved capable of performing a whole variety of bending applications. It is very easy to manufacture specialised tooling such as pipe bending, bar straightening and angle bending brackets and cleats. The forward and return bending stroke travel can be set with minimum travel, sufficient enough to reload the material therefore reducing cycle time.

These machines are extremely adaptable and capable of a wide range of bending applications. Speak to us about your requirements, and what tooling you would need.

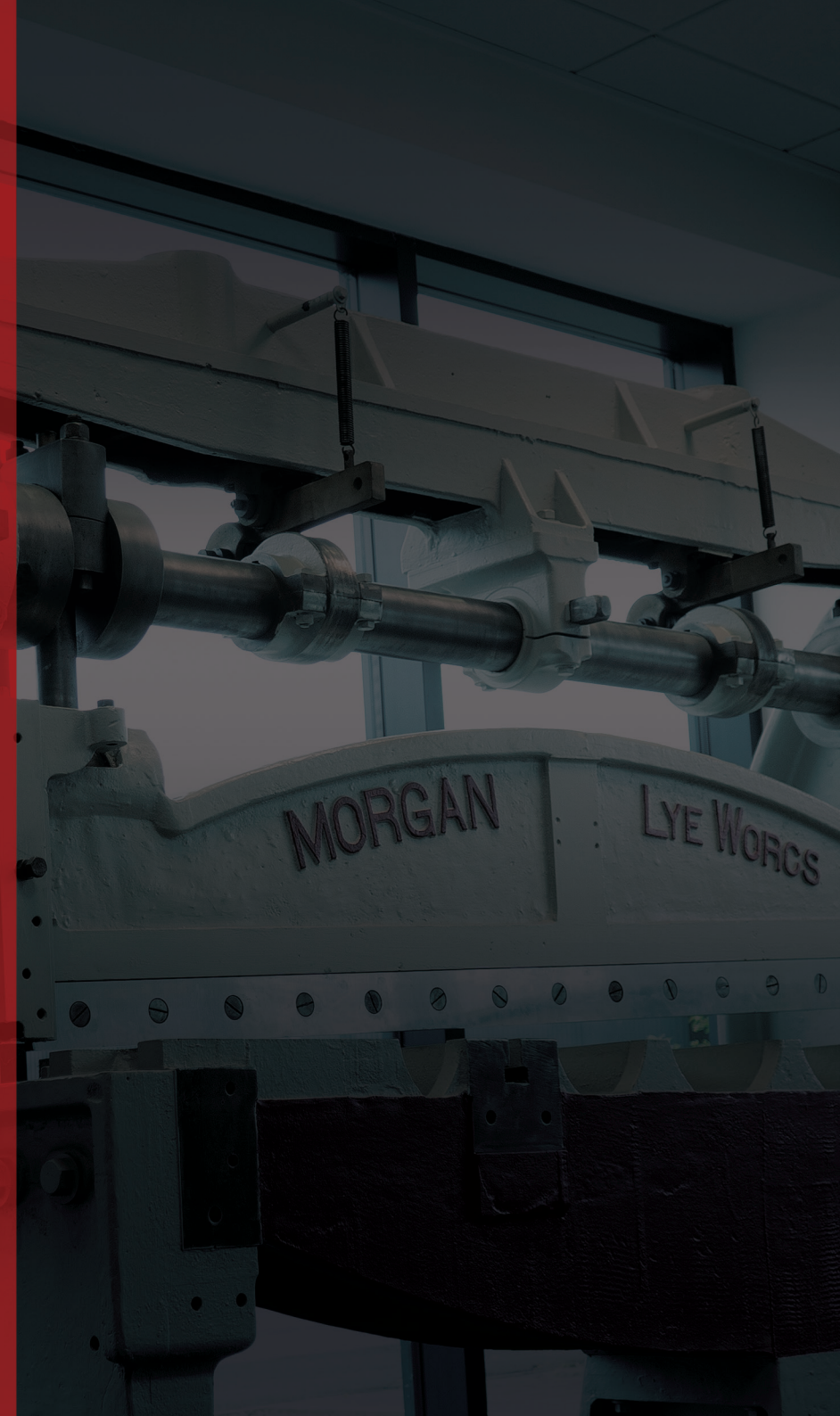



**SINCE
1872**

MORGAN RUSHWORTH: 150 YEARS IN THE MAKING

The Morgan Rushworth brand has always stood for “Excellence” and still delivers consistently high quality machinery to discerning clients around the globe. From the very beginning to the current day, Morgan Rushworth has become known for setting new standards in the metalworking industry. We are very thankful for the continued loyalty of our customers and repay them by guaranteeing the same high standards which they have come to expect.

Morgan Rushworth started off as two separate companies, each with individual success until 1972, when they successfully merged and grew steadily to become a renowned company of today. In June 2008, the company was acquired by the UK Machinery Group with a commitment to continue in the passionate development of traditionally high quality and reliable machines that have become synonymous with the Morgan Rushworth name.

 **MORGAN
RUSHWORTH**
SINCE 1872

Morgan Rushworth **HBM / HBM NC**

Highly versatile, multi-purpose pressing machines

01

TONNAGE RANGE

The HBM Range is available in a variety of tonnages, from 10 to 100 depending on your pressing requirements.

02

ROBUST

The heavy-duty frame of the HBM ensures that it's ready for a wide range of tasks, including bending, pressing, folding and even shearing.





03

FLEXIBLE

A vast range of tooling available for all manner of workshop tasks, sheet bending or straightening, tube bending, shearing, rotary bending and much more!

04

VERSATILE

Tooling heights range from 150mm all the way up to 300mm, with a range of Multi-Way V-Dies to suit any bending requirements.

05

CONTROL

Foot Pedal Control with Three Position Digital Readout, or upgrade to the NC model for additional control, programming and repeatability.



HEAVY DUTY FRAME

The robust frames are built to last, with powerful hydraulics for heavy workshop use.



FOOT PEDAL WITH DIGITAL READ OUT

The foot pedal control offers a three position digital readout (Actual Position, Adjustable Forward Stroke Position and Adjustable Return Stroke Position).



ACCURACY & REPEATABILITY

Each machine features a measured rule stop, allowing for fast, accurate and repeatable folding or bending processes.

**GAN
NORTH**
SINCE 1872

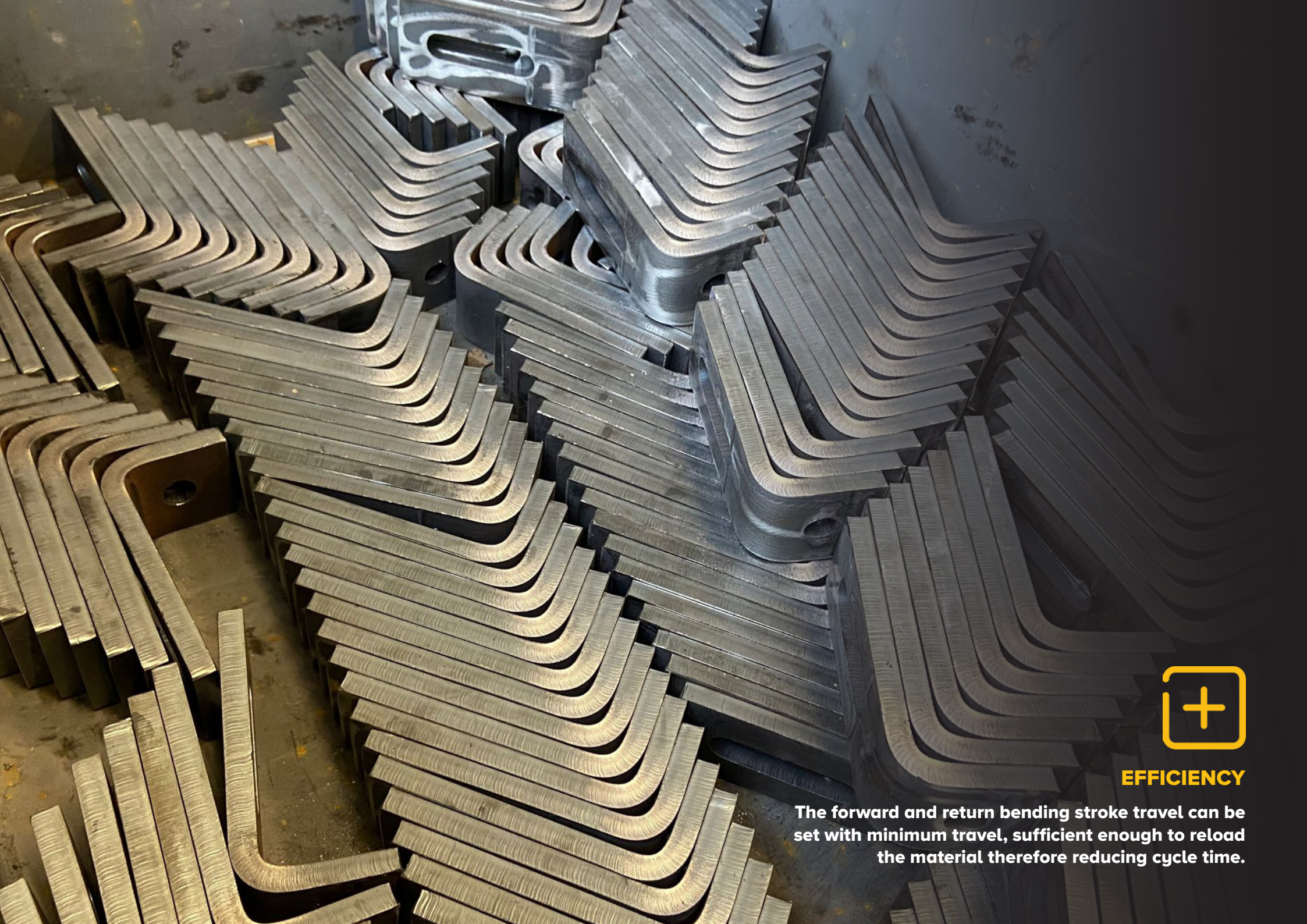

EFFICIENCY

The forward and return bending stroke travel can be set with minimum travel, sufficient enough to reload the material therefore reducing cycle time.



PERFECT FOR PROTOTYPING

HBM's are perfect for prototyping and experimenting before a full production run.



PRODUCTION READY

With measured rules and stroke limits, you can quickly configure a HBM for a production run, whether it's 10 pieces, or 10,000.



NC CAPABLE

As well as the standard foot pedal, we can also offer the machine with an NC Controller, and an optional powered backgauge for further productivity.



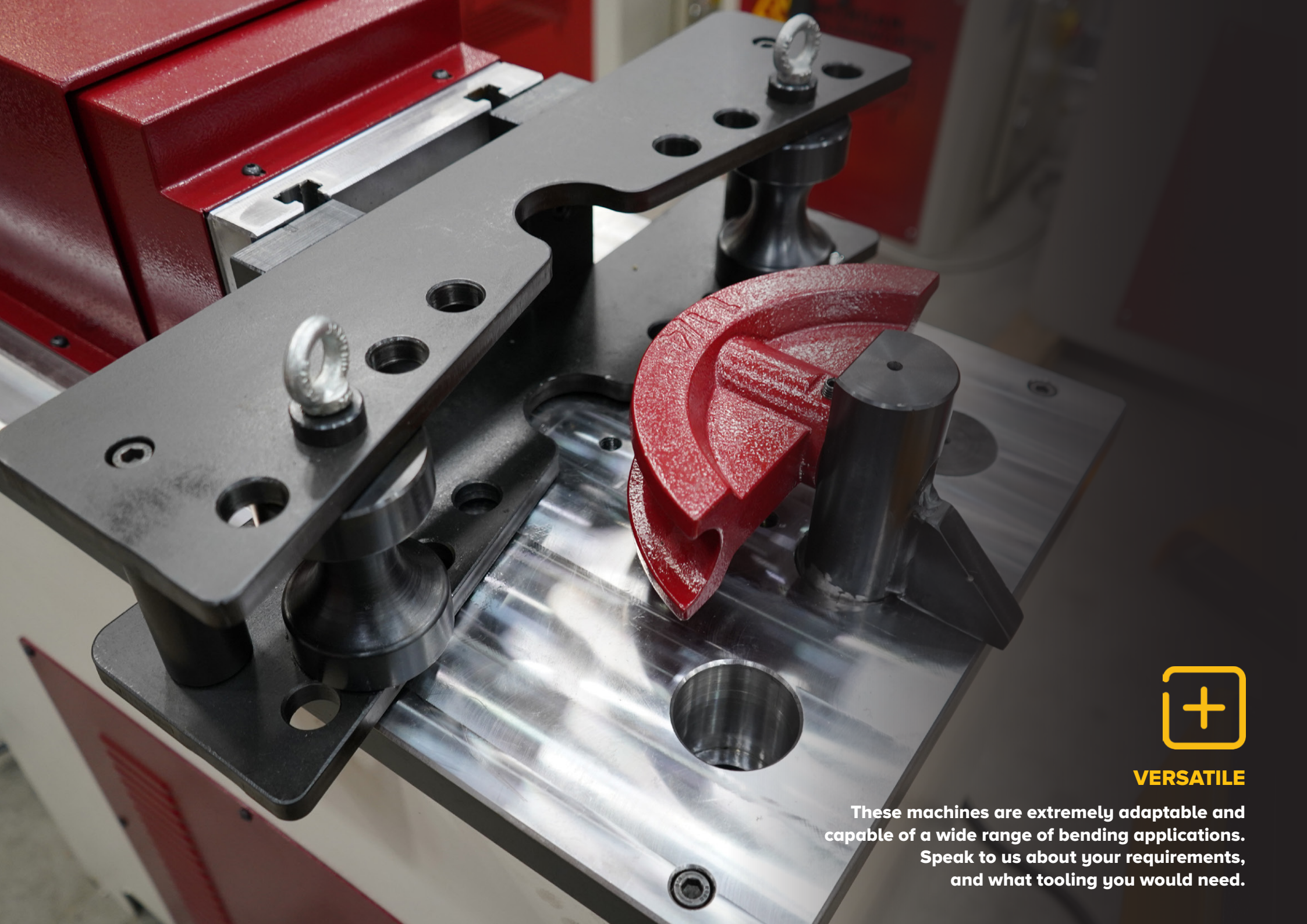

VERSATILE

These machines are extremely adaptable and capable of a wide range of bending applications. Speak to us about your requirements, and what tooling you would need.

Tooling Range

The Morgan Rushworth HBM Range can be fitted with a vast range of tooling, to suit your requirements, from bending, folding, cropping or straightening and more!



The standard tooling for all HBMs is a v-die and punching tool.



A 30° bolt punch, paired with a multi-way v-die for tighter than 90° folds.



2 jaw bending tool for thick wall pipes up to 90°.

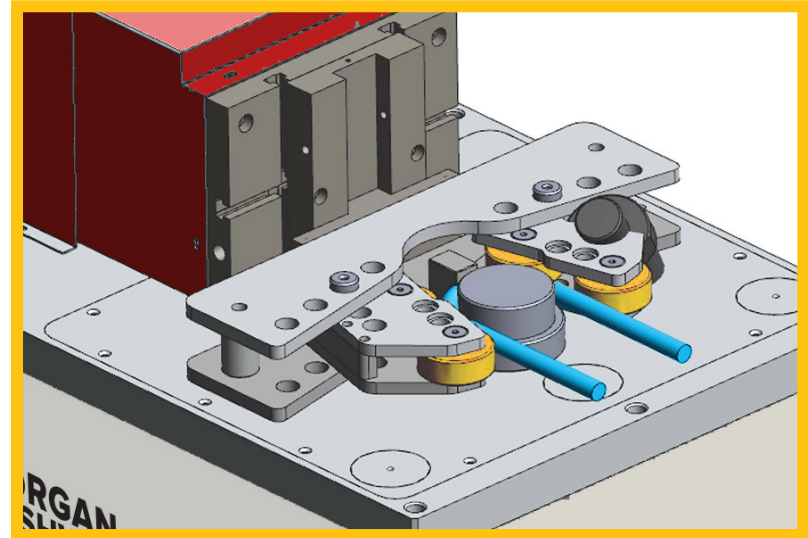

4 jaw bending tool for round, square, rectangular bars and thick pipes up to 180°.

Tooling Range

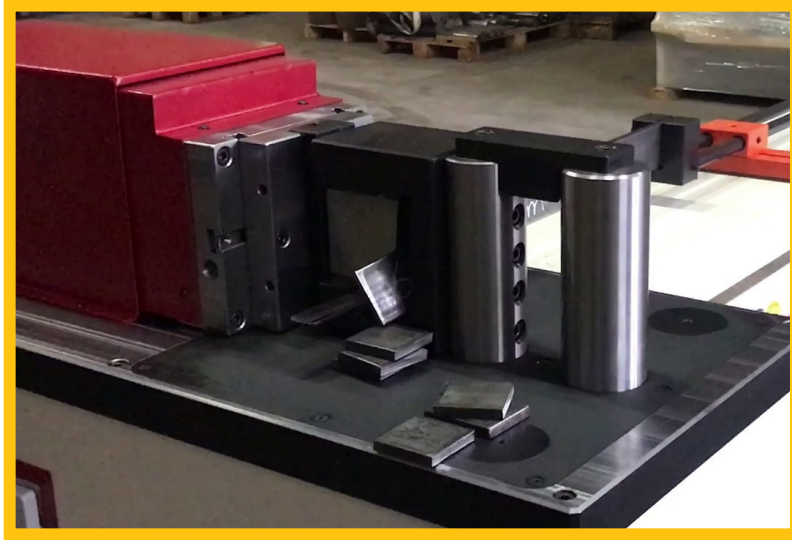

Shearing / Cropping unit for flat bars.



Standard tooling with anti-deflection bar.

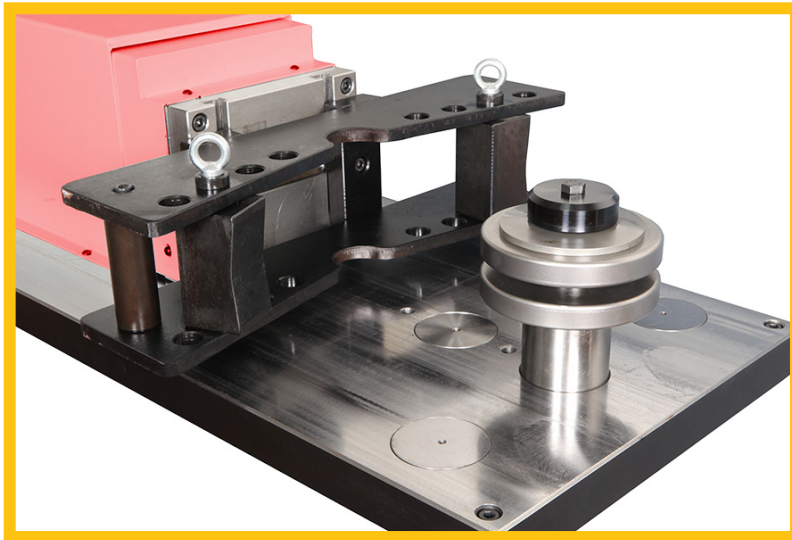

Flat bar bending tool.

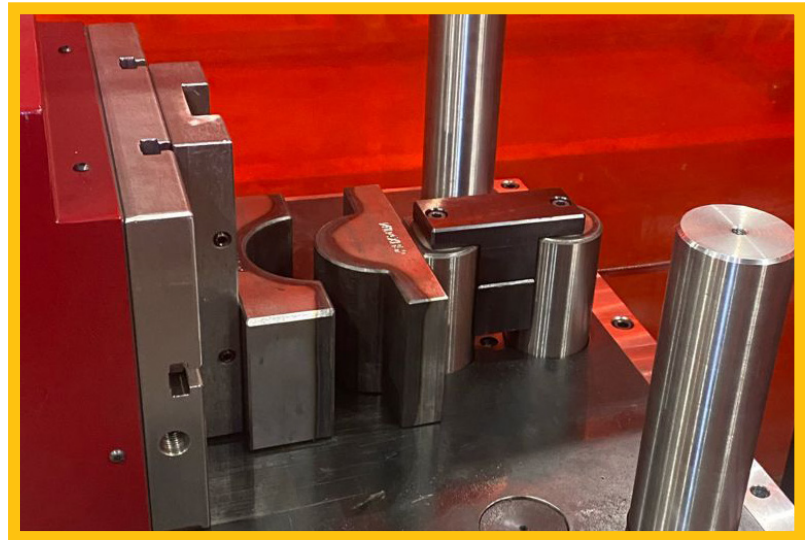

Pipe clamp pressing and forming tool for flat bar bending.

Tooling Range

These are just some examples of the standard punches and dies available for the HBM Range.

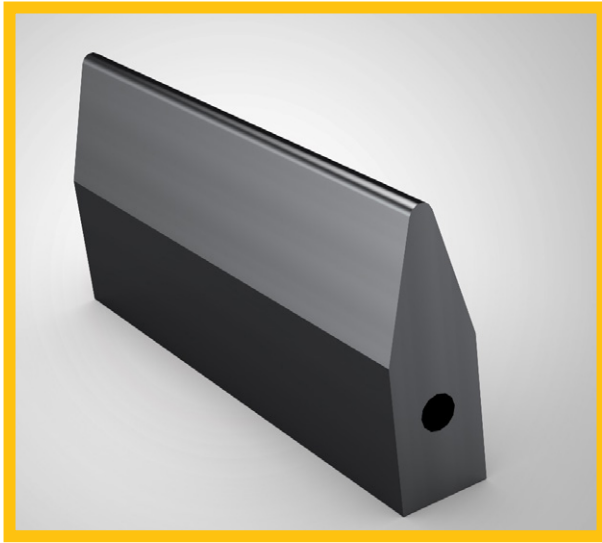

R5 30° Punch (Other Radii available) - Standard sizes include R1, R5 and R10

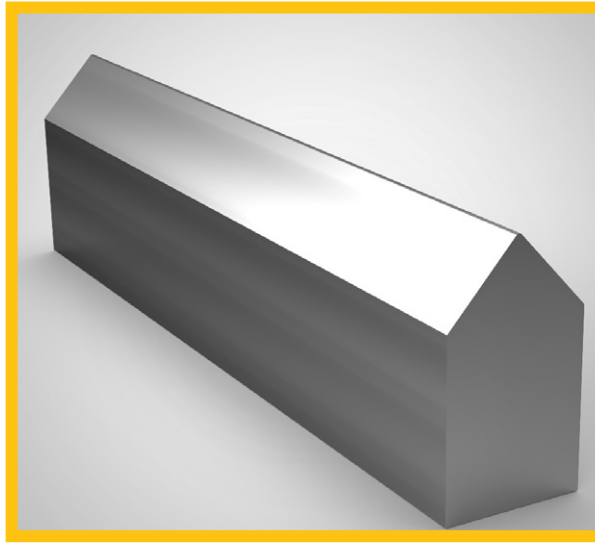

R5 85° Punch (Other Radii available) - Standard sizes include R1, R5 and R10



30° Bolt Punch (Available in a variety of heights)

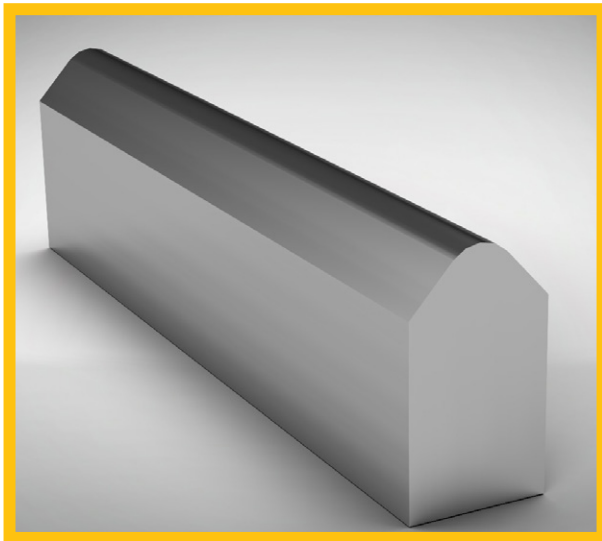

R10 85° Punch (Other Radii available) - Standard sizes include R1, R5 and R10

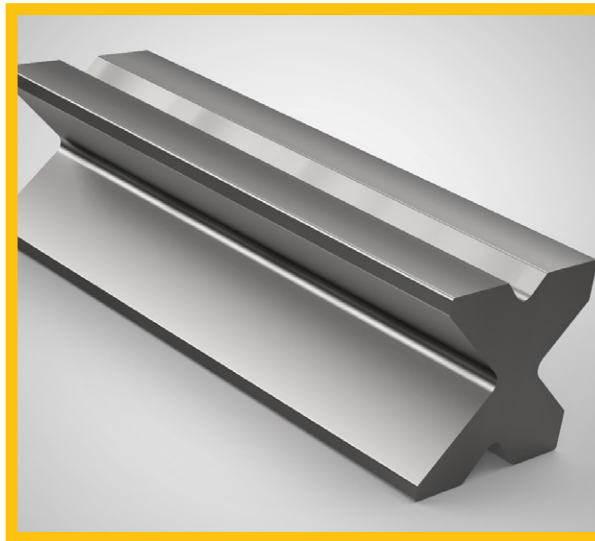

Multi-V 4-Way Die
(Sizes include 16, 22, 35 and 50).

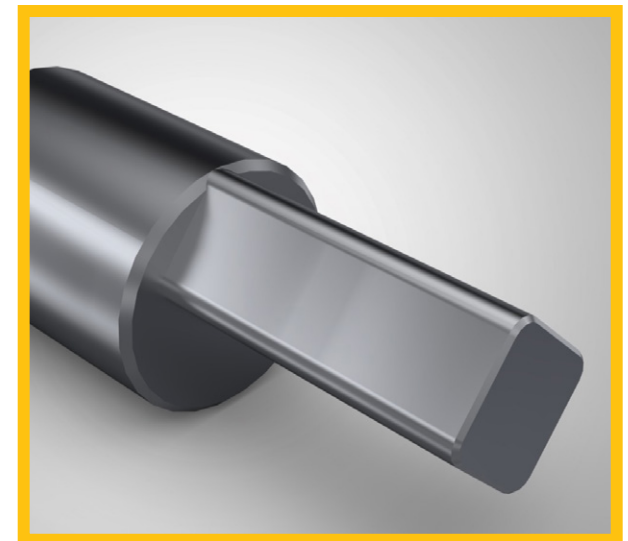

85° Bolt Punch

Tooling Range

Standard V-Die sizes include 50, 63, 80, 100, 125 & 160

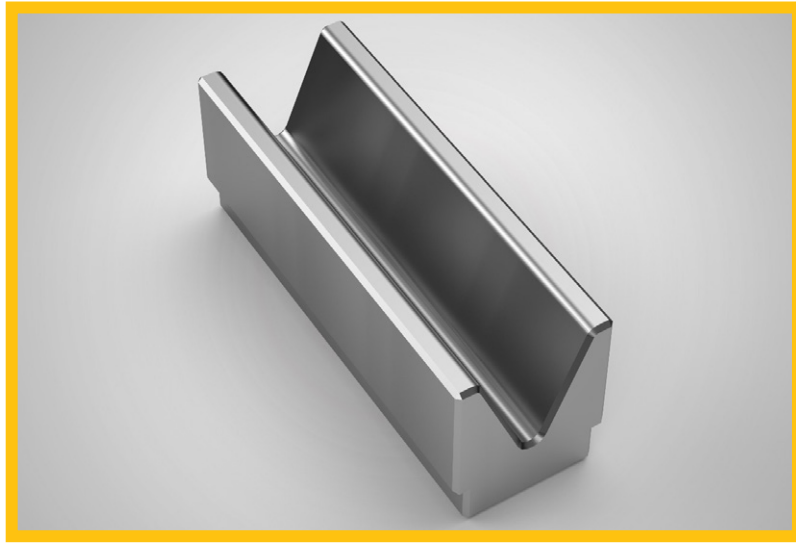

V50 60° V Die

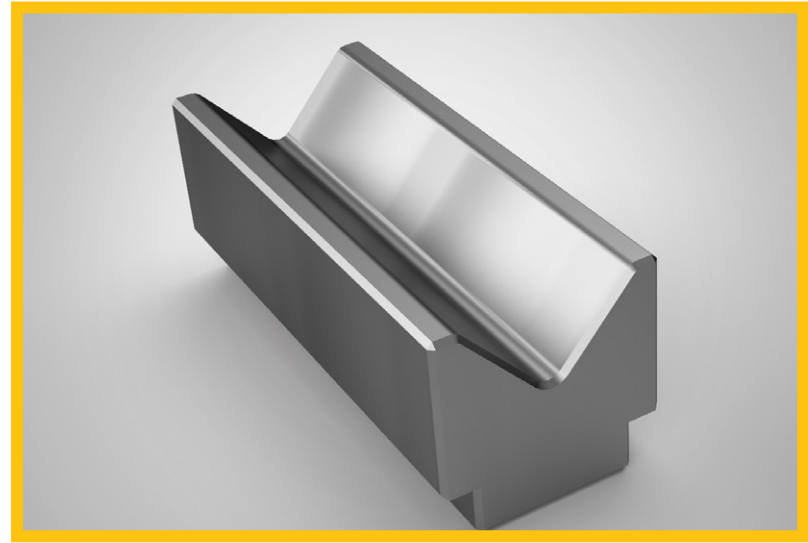

V63 85° V Die

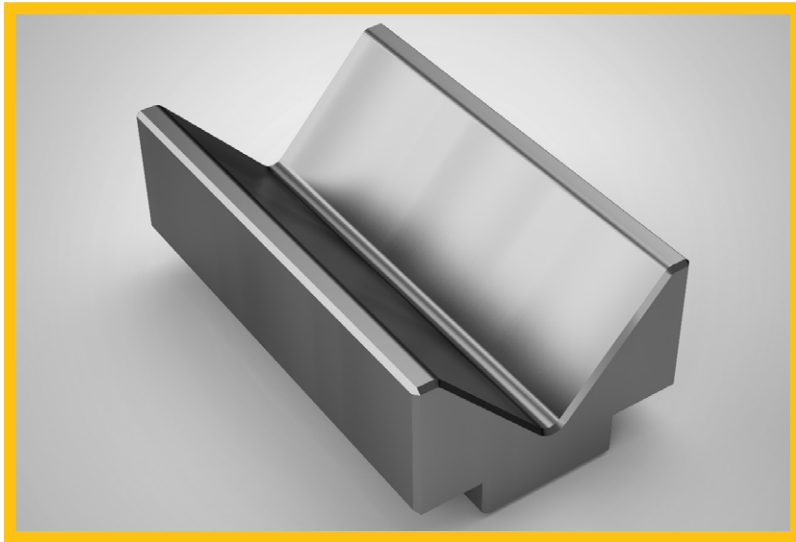

V80 85° V Die

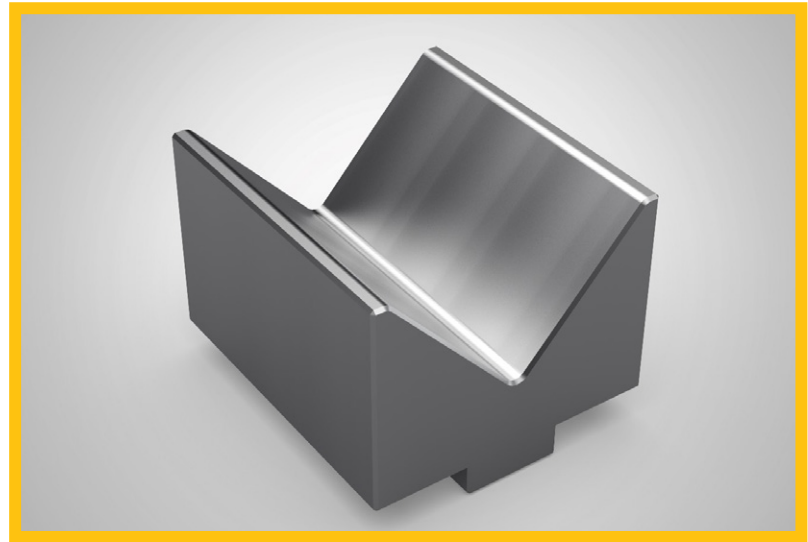

V125 85° V Die

Tooling Range

We can also offer custom tooling for individual parts or projects to match specific needs that you have, below is an example of some of the tooling we can offer.



Larger V dies for bending thicker plates



Flat bar straightening tool.



4 jaw bending tool with 30° bolt punch for bending specific profiles.

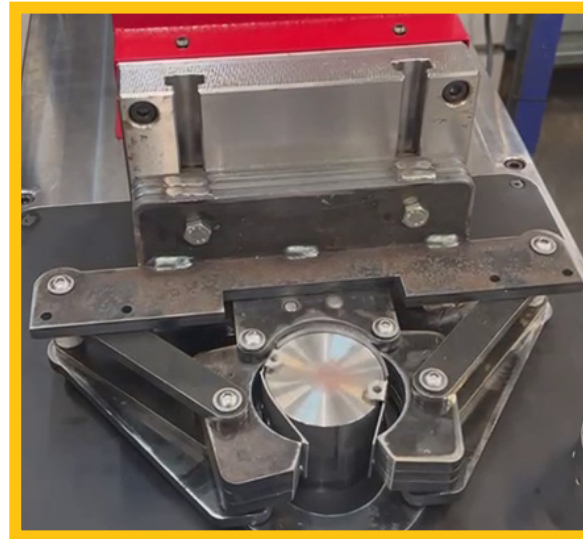

Self-Closing tooling for creating closed shapes (squares, circles etc).

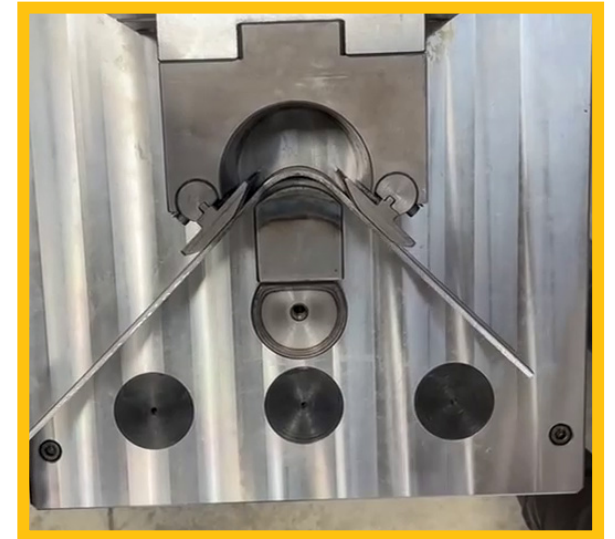

Single die tool, with revolving pin for mark-free bending on plate.

NC Controller

The NC Controller supplied with this machine allows you to save up to 99 programmes, of 15 steps each.

Perfect for regular jobs, or repeated steps for a larger or complex project. The optional automated back gauge will improve productivity even further.



**NC CONTROLLER - AUTO /
MANUAL MODES**



**NC CONTROLLER - 15 STEPS
PER PROGRAMME**

TECHNICAL SPECIFICATIONS

MODEL		HBM 10/150	HBM 20/200	HBM 30/250	HBM 40/250	HBM 50/300	HBM 80/300	HBM 100/300
STOCK CODE		M4520	M4521	M4522	M4523	M4524	M4525	M4526
Max Pressure at 200 bars	ton	10	20	30	40	50	80	100
Oil Tank Capacity	lt	12	12	40	40	60	120	120
Bending Capacity Flat Material	mm	150 x 8	200 x 12	250 x 12	250 x 24	300 x 15	300 x 20	300 x 25
Bending Capacity Round Tubes	mm	42 x 3.2	48 x 4.0	60 x 4.0	60 x 5.0	76 x 4.0	90 x 9	114 x 10
Max Stroke	mm	185	185	285	285	285	285	285
Diameter of Bolts	mm	60	80	80	80	90	105	105
Height of Toolings	mm	150	200	250	250	300	300	300
Working Speed	mm/sec	10	10	10	10	10	10	10
Return Speed	mm/sec	10	10	10	10	10	10	10
Motor Power	Kw	1.1	2.2	3	4	5.5	10	10
Net Weight	Kg	250	530	1050	1050	1450	1700	1700
Size of the Table (LxW)	mm	450 x 900	480 x 1060	660 x 1250	660 x 1250	600 x 1250	750 x 1425	750 x 1425
Working Height	mm	915	930	930	930	930	930	930
Length	mm	900	1150	1250	1250	1400	1430	1430
Width	mm	450	480	650	650	600	750	750
Height	mm	1130	1200	1250	1250	1500	1450	1450
Size of Packing (LxWxH)	mm	100 x 500 x 1500	600 x 1150 x 1700	700 x 1280 x 1750	700 x 1280 x 1750	1450 x 650 x 1800	1500 x 750 x 1800	1500 x 750 x 1800

 **MORGAN
RUSHWORTH**
SHAPING THE INDUSTRY SINCE 1872

*Scan this QR Code
to see the Morgan
Rushworth HBM
Range in action on
our YouTube Channel*



“Horizontal Bending Machines are an extremely adaptable and dependable platform for a host of different bending and folding tasks. From standard tools to complex custom tooling, there are numerous solutions available”

SELMACHTM
MACHINERY

For more information, pricing, and availability, please contact the sales team at Selmach Machinery:

E: sales@selmach.com
T: 01432 346 580
W: www.selmach.com

